

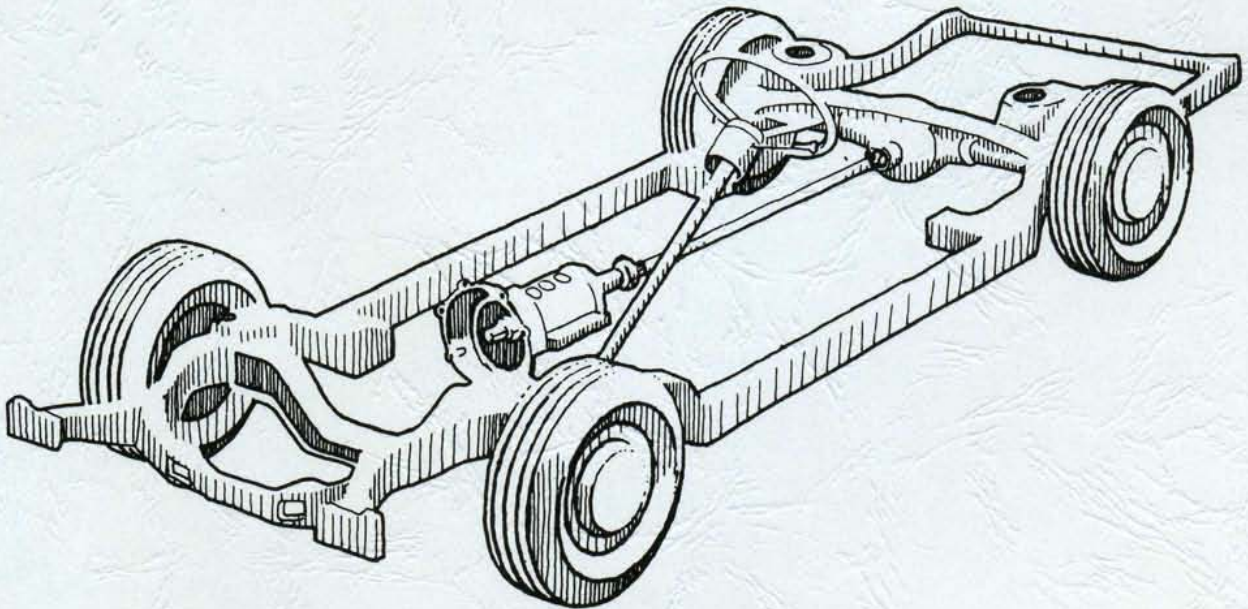

1972

car shop manual

volume I chassis



Copyright © 2007, Forel Publishing Company, LLC, Woodbridge, Virginia

All Rights Reserved. No part of this book may be used or reproduced in any manner whatsoever without written permission of Forel Publishing Company, LLC. For information write to Forel Publishing Company, LLC, 3999 Peregrine Ridge Ct., Woodbridge, VA 22192

1972 Ford Car Shop Manual
ISBN: 0-9673211-9-0
EAN: 978-0-9673211-9-6

Forel Publishing Company, LLC
3999 Peregrine Ridge Ct.
Woodbridge, VA 22192

Marketed by MustangServiceManual.com

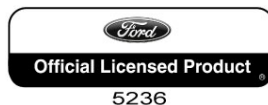

This publication contains material that is reproduced and distributed under a license from Ford Motor Company. No further reproduction or distribution of the Ford Motor Company material is allowed without the express written permission of Ford Motor Company.

Disclaimer

Although every effort was made to ensure the accuracy of this book, no representations or warranties of any kind are made concerning the accuracy, completeness or suitability of the information, either expressed or implied. As a result, the information contained within this book should be used as general information only. The author and Forel Publishing Company, LLC shall have neither liability nor responsibility to any person or entity with respect to any loss or damage caused, or alleged to be caused, directly or indirectly by the information contained in this book. Further, the publisher and author are not engaged in rendering legal or other professional services. If legal, mechanical, electrical, or other expert assistance is required, the services of a competent professional should be sought.

1972 car shop manual

volume 1 chassis

group index

Identification Codes

10

Wheels and Tires

11

Brakes

12

Steering

13

Suspension

14

Driving Axles and Drive Shafts

15

Clutch and Manual Transmission

16

Automatic Transmissions

17

Ford Marketing Corporation
Ford Customer Service Division
Service Technical Communications Department
Publications Section

FOREWORD

This manual is divided into five volumes: 1. Chassis; 2. Engine; 3. Electrical; 4. Body; 5. Maintenance and Lubrication. These volumes should provide Service Technicians with complete information covering normal service repairs on all 1972 model passenger cars built by the Ford Companies in the U.S. and Canada. As changes in the product occur, this information will be updated by Service Bulletins that will supersede the information in the manual.

Information in each volume is grouped by system or component plus "General Service" part which contains information common to several similar components.

The table of contents on the first page of each volume indicates the general content of the book and provides a handy tab locator to make it easy to find the first page of each "Group." That page will contain an index to "Parts" and the first page of each "Part" contains a detailed index which gives page location for each service operation covered. Page numbers are consecutive in each "Part."

To make reference easier, information has been broken down into smaller units so that essentially there is now one "Part" for each component or system. Group numbers indicate the volume in which the group may be found.

EXAMPLE:

11-02-21

Volume 1 – Group 11; Part 02; Page 21

The descriptions and specifications in this manual were in effect at the time this manual was approved for printing. The Ford Companies reserve the right to discontinue models at any time, or change specifications or design, without notice and without incurring obligation.



Service Publications

Identification Codes

GROUP
10

OFFICIAL VEHICLE IDENTIFICATION NUMBER

The official Vehicle Identification Number (VIN) (Fig. 1) for title and registration purposes is stamped on a metal tab that is fastened to the instrument panel close to the windshield on the driver's side of the car and is visible from outside.

VEHICLE CERTIFICATION LABEL

The Vehicle Certification Label (V.C. Label) (Fig. 1) is attached to the rear face of the left front door on all 4-door models and Mustangs and Cougars, and to the left door lock pillar on all other 2-door models. The upper half

of the label contains the name of the manufacturer, the month and year of manufacture and the certification statement.

The V.C. label also contains the Vehicle Identification Number. This number is also used for warranty identification of the vehicle. The first number indicates the model year. The letter following the model year number indicates the manufacturing assembly plant. The next two numbers designate the Body Serial Code followed by a letter expressing the Engine Code.

The last six digits of the Vehicle Identification Number indicate the Consecutive Unit Number of each unit built at each assembly plant. The Consecutive

Unit Numbers begin as follows:

- 100,001—Ford, Torino, Mustang, Thunderbird, Maverick and Pinto.
- 500,001—Mercury, Meteor, Montego, Cougar, Comet.
- 800,001—Lincoln Continental and Continental Mark IV.

The remaining information on the V.C. Label consists of pertinent vehicle identification codes:

The BODY code is two numerals and a letter identifying the body style.

The COL (color) code is a number and letter indicating the exterior paint color code.

The TRIM code consists of a two-letter or a letter-number combination designating the interior trim.

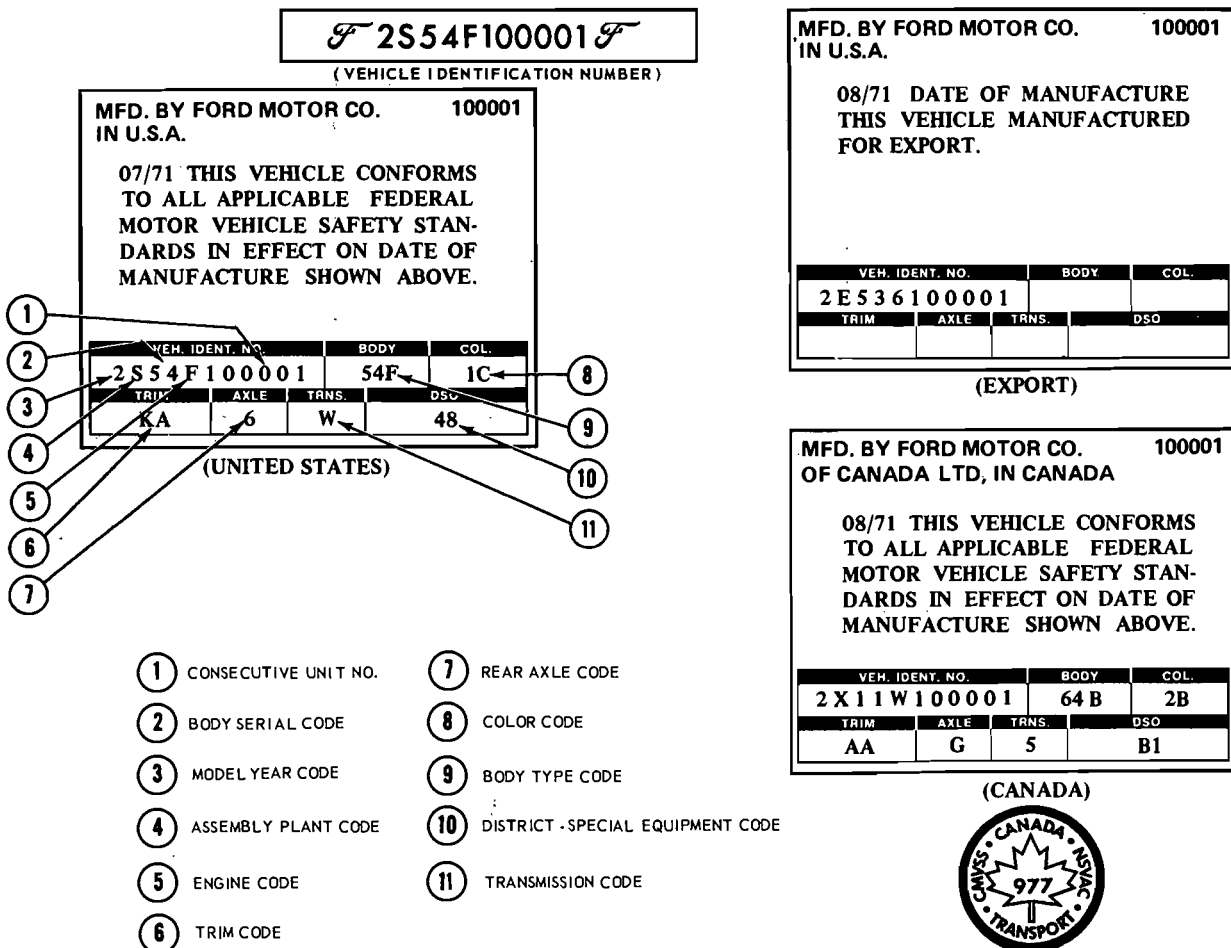

FIG. 1 Vehicle Identification and Certification Labels

The AXLE code is a number or letter indicating the rear axle ratio and standard or locking type axles.

The TRNS. code is a number or letter indicating the type of transmission.

The DSO code, consisting of two numbers, designates the district in which the car was ordered and may appear in conjunction with a Domestic Special Order or Foreign Special Order number when applicable. Ford of Cana-

da DSO codes consist of a letter and a number.

The following charts provide the various codes and their respective identification:

ASSEMBLY PLANT CODES

Code Letter	
A	Atlanta
B	Dakville (Canada)
E	Mahwah
F	Dearborn
G	Chicago
H	Lorain
J	Los Angeles
K	Kansas City
N	Norfolk
P	Twin Cities
R	San Jose
S	Allen Park (Pilot)
T	Metuchen
U	Louisville
W	Wayne
X	St. Thomas
Y	Wixom
Z	St. Louis

ENGINE CODES

Codes	No. of Cyls.	Displacement
U	6	170 CID
T	6	200 CID-1V
2⓪	6	200 CID-1V
L	6	250 CID-1V
3⓪	6	250 CID-1V
V	6	240 CID-1V
E	6	240 CID-1V (Taxi)
F	8	302 CID-2V
6⓪	8	302 CID-2V
D	8	302 CID-2V (Taxi)
H	8	351 CID-2V
O	8	351 CID-4V
R	8	351-4V HO
S	8	400 CID-2V
N	8	429 CID-4V
P	8	429 CID-4V Police
A	8	460 CID-4V
W	4	98-IV - 1600cc
X	4	122-2V - 2000cc

⓪ Low Compression Export

TRANSMISSION CODES

Codes	Type
1	3-Speed Manual
5	4-Speed Manual
E	4-Speed Manual
W	Automatic (C4)
U	Automatic (C6)
X	Automatic (FMX)
Z	Automatic (C6 Special)

REAR AXLE RATIO CODES

Conventional	Lock	Ratio
2	K	2.75:1
3	-	2.79:1
4	M	2.80:1
6	O	3.00:1
7	-	3.18:1
9	R	3.25:1
A	S	3.50:1
B	-	3.07:1
G	-	3.55:1
H	-	3.78:1
-	V	3.91:1

DISTRICT CODES

LINCOLN-MERCURY

Code	District
11	Boston
15	New York
16	Philadelphia
17	Washington
21	Atlanta
22	Dallas
23	Jacksonville
26	Memphis
31	Buffalo
32	Cincinnati
33	Cleveland
34	Detroit
41	Chicago
42	St. Louis
46	Twin Cities
51	Denver
52	Los Angeles
53	Oakland
54	Seattle
84	Home Office Reserve
90	Export

FORD OF CANADA

Mercury Code	Region	Ford Code
A1	Central	B1
A2	Eastern	B2
A3	Atlantic	B3
A4	Midwestern	B4
A6	Western	B6
A7	Pacific	B7
I2	Export	I2

DISTRICT CODES

FORD

Code	District
11	Boston
12	Buffalo
13	New York
14	Pittsburgh
15	Newark
16	Philadelphia
17	Washington
21	Atlanta
22	Charlotte
23	Memphis
24	Jacksonville
25	Richmond
26	New Orleans
28	Louisville
41	Chicago
42	Cleveland
43	Milwaukee
45	Lansing
46	Indianapolis
47	Cincinnati
48	Detroit
52	Dallas
53	Kansas City
54	Omaha
55	St. Louis
56	Davenport
57	Houston
58	Twin City
71	Los Angeles
72	San Jose
73	Salt Lake City
74	Seattle
75	Phoenix
76	Denver
83	Government
84	Home Office Reserve
85	American Red Cross
87	Body Company
89	Transportation Services
90-99	Export

EXTERIOR PAINT COLOR CODES

Code	M-32-J Number	Color	Code	M-32-J Number	Color
1A	5100-A	Lt. Gray Met.	4G	5103-A	Med. Ivy Bronze Met.
1C	1724-A	Black	4P	3462-A	Med. Green Met.
1D	5106-A	Silver Met.	40	3542-A	Dk. Green Met.
2A	1730-A	Calypso Blue	5A	3314-A	Lt. Pewter Met.
2B	3560-A	Bright Red	5C	5008-A	Ginger Bronze Met.
2E	2008-A	Red	5D	5102-A	Ginger Bronze Met.
2G	5070-A	Med. Red Met.	5F	5099-A	Dk. Brown Met.
2J	3059-A	Maroon	5G	5105-A	Lt. Copper Met.
3B	3429-A	Lt. Blue	5H	3564-A	Ginger Met.
3C	5007-A	Med. Blue Met.	5J	5071-A	Med. Ginger Bronze Met.
3D	5087-A	Med. Blue Met.	5L	5003-A	Tan
3F	3657-A	Grabber Blue	6B	3565-A	Lt. Goldenrod
3H	5088-A	Dk. Blue Met.	6C	3492-A	Med. Goldenrod
3J	3077-A	Bright Blue Met.	6D	3341-A	Yellow
4A	5023-A	Pastel Lime	6E	5080-A	Med Brt. Yellow
4B	5025-A	Bright Green Gold Met.	6F	5079-A	Brt. Yellow Gold Met.
4C	5072-A	Ivy Bronze Met.	6G	5105-A	Lt. Copper Met.
4D	5069-A	Med. Ivy Bronze Met.	6J	1736-A	Gray Gold Met.
4F	5021-A	Med. Lime Met.	9A	1619-A	White

Identification Data—Body Serial and Style Codes

BODY SERIAL AND STYLE CODES

Vehicle	Body Serial Code	Body Style Code	Body Type	Model	Vehicle	Body Serial Code	Body Style Code	Body Type	Model	
TORINO	27	53B	4-Dr. Sedan Hardtop	Torino	MERCURY	48	57B	4-Dr. Hardtop	Monterey— Custom	
	25	65B	2-Dr. Hardtop			54	53F	4-Dr. Sedan Hardtop		
	30	65D	2-Dr. Hardtop	56		65F	2-Dr. Hardtop			
	31	53D	4-Dr. Sedan Hardtop	58		57F	4-Dr. Hardtop			
	35	63R	2-Dr. Fastback	63		53H	4-Dr. Sedan Hardtop	Marquis		
	38	65R	2-Dr. Hardtop	66		65H	2-Dr. Hardtop			
	40	71B	Torino	6B		57H	4-Dr. Hardtop			
	42	71D	Gran. Torino	Wagons 4-Dr.		62	53K	4-Dr. Sedan Hardtop	Brougham	
	43	71K	Torino Squire			64	65K	2-Dr. Hardtop		
	47	97D	Ranchero 500	Ranchero		67	57K	4-Dr. Hardtop	Monterey Wagon	
	48	97R	Ranchero GT			72	71B	4-Dr. 6 Pass. ②		
49	97K	Ranchero Squire	74		71H	4-Dr. 6 Pass. ②	Marquis Wagon			
COMET	30	54B	4-Dr. Sedan	Standard	76	71K	4-Dr. 6 Pass. ②	Marquis Colony Park Wagon		
	31	62B	2-Dr. Sedan ①		MERCURY (CANADA ONLY)	40	53X	4-Dr. Sedan Hardtop	Marquis	
COUGAR	91	65D	2-Dr. Hardtop ①	Standard	41	65X	2-Dr. Hardtop			
	92	76D	Convertible		42	57X	4-Dr. Hardtop			
	93	65F	2-Dr. Hardtop		XR-7 Luxury	METEDR (CANADA)	20	53B	4-Dr. Sedan Hardtop	Rideau
	94	76F	Convertible		FORD	52	65D	2-Dr. Hardtop (Canada Only)	Custom 500	
FORD	51	54B	4-Dr. Sedan	Custom	22	53D	4-Dr. Sedan Hardtop	Rideau 500		
	52	65D	2-Dr. Hardtop (Canada Only)		23	65D	2-Dr. Hardtop	Montcalm		
	53	54D	4-Dr. Sedan		25	53F	4-Dr. Sedan Hardtop			
	54	54F	4-Dr. Sedan		26	65F	2-Dr. Hardtop			
	56	57F	4-Dr. Hardtop	Galaxie 500	27	57F	4-Dr. Hardtop	Station Wagons-4 Dr.		
	58	65F	2-Dr. Hardtop		36	71D	Rideau 500-6 Pass. ②			
	61	76H	Convertible		LTD	38	71F	Montcalm-6 Pass. ②		
	62	65H	2-Dr. Hardtop	LTD Brougham	MONTEGO	02	53B	4-Dr. Sedan Hardtop	Montego	
	63	53H	4-Dr. Sedan Hardtop		03	65B	2-Dr. Hardtop	Montego MX		
	64	57H	4-Dr. Hardtop		04	53D	4-Dr. Sedan Hardtop			
	66	53K	4-Dr. Sedan Hardtop		05	63D	2-Dr. Fastback			
	67	57K	4-Dr. Hardtop	Custom Ranch	07	65D	2-Dr. Hardtop	Montego MX Brougham		
	68	65K	2-Dr. Hardtop		10	53K	4-Dr. Sedan Hardtop			
	70	71B	4-Dr. Wagon		Custom Ranch	11	65K	2-Dr. Hardtop	Montego GT	
	72	71D	4-Dr. Wagon	Custom 500 Ranch ②	16	63R	2-Dr. Fastback	Station Wagons-4 Dr.		
74	71F	4-Dr. Wagon	Country Sedan ②	08	71D	Montego MX				
76	71H	4-Dr. Wagon	Country Squire ②	18	71K	Montego MX Villager				
LINCOLN	81	65A	2-Dr. Hardtop	MUSTANG	01	65D	2-Dr. Hardtop	Standard		
CONTINENTAL	82	53A	4-Dr. Sedan Hardtop		02	63D	2-Dr. Sportsroof ③			
MARK IV	89	65D	2-Dr. Hardtop		03	76D	Convertible	Grande		
MAVERICK	91	62A	2-Dr. Sedan		04	65F	2-Dr. Hardtop			
	92	54A	4-Dr. Sedan		05	63R	2-Dr. Sportsroof		Mach 1	
	93	62D	2-Dr. Sport Sedan	PINTO	10	62B	2-Dr. Sedan	Standard		
MERCURY	44	53B	4-Dr. Sedan Hardtop	11	64B	3-Dr. Model				
	46	65B	2-Dr. Hardtop	12	73B	2-Dr. Wagon				
				THUNDERBIRD	87	65K	2-Dr. Hardtop			

① Also "GT" ② Also available w/Dual Face Rear Seats ③ Also "BOSS"

Identification Data—Trim Codes

INTERIOR TRIM CODES

Code	Trim Scheme	Code	Trim Scheme	Code	Trim Scheme	Code	Trim Scheme
PINTO		LS	White w/Ginger	Sebring Knit/Corinth. Vinyl		KF	Ginger
AA	Akron/Corinth. Vinyl	LB	White w/Beige	GA	Black	KR	Med. Green
AB	Black	Manston B/Cloth and Corinth. Vinyl		GB	Med. Blue	KW	White w/Black
AR	Med. Green	MW	White & Black w/White	GE	Vermilion	KL	White w/Blue
AT	Med. Beige	COMET		GF	Med. Ginger	K9	White w/Tobacco
AW	White w/Black	Melrose/Corinth. Vinyl		GR	Med. Green	K5	White w/Green
AL	White w/Blue	AA	Black	GW	White	MA	Black
AS	White w/Ginger	AY	Lt. Gray Gold	COUGAR		MB	Med. Blue
A5	White w/Green	Check B/Cloth and Corinth. Vinyl		Ruffino/Corinth. Vinyl		MF	Ginger
Manston B/Cloth & Corinth. Vinyl		BA	Black	AA	Black	MR	Med. Green
BA	Black	BB	Med. Blue	AB	Med. Blue	MW	White w/Black
BB	Med. Blue	BF	Med. Ginger	AD	Dk. Red	ML	White w/Blue
BF	Med. Ginger	BT	Med. Beige	AF	Med. Ginger	M9	White w/Tobacco
BR	Med. Green	BY	Lt. Gray Gold	AR	Med. Green	M5	White w/Green
BT	Med. Beige	Province B/Cloth and Corinth. Vinyl		AW	White	Inverness B/Cloth and Corinth. Vinyl	
BW	White w/Black	CA	Black	Random Stripe B/Cloth and Corinth. Vinyl		NA	Black
BL	White w/Blue	CB	Med. Blue	BA	Black	NB	Med. Blue
BS	White w/ Ginger	CE	Vermilion	BB	Med. Blue	NR	Med. Green
B5	White w/ Green	CY	Lt. Gray Gold	BF	Med. Ginger	NY	Lt. Gray Gold
Sebring Knit/Corinth. Vinyl		Sebring Knit/Corinth. Vinyl		BR	Med. Green	NZ	Tobacco
CA	Black	EA	Black	Sebring Knit/Corinth. Vinyl		Sphere B/Cloth and Corinth. Vinyl	
CB	Med. Blue	EB	Med. Blue	CA	Black	QA	Black
CF	Med. Ginger	EE	Vermilion	CB	Med. Blue	QB	Med. Blue
CR	Med. Green	EY	Lt. Gold	CD	Dk. Red	QR	Med. Green
CT	Med. Beige	FA	Black	CF	Med. Ginger	QY	Lt. Gray Gold
CW	White w/ Black	FB	Med. Blue	CR	Med. Green	OZ	Tobacco
CL	White w/ Blue	FE	Vermilion	CW	White	Ruffino/Corinth. Vinyl	
CS	White w/ Ginger	FY	Lt. Gray Gold	Leather/Mateao. Vinyl		RA	Black
C5	White w/ Green	Province B/Cloth and Corinth. Vinyl		DA	Black	RB	Med. Blue
MAVERICK		GE	Vermilion	DB	Med. Blue	RF	Ginger
Melrose/Corinth. Vinyl		GY	Lt. Gray Gold	DD	Dk. Red	RR	Med. Green
AA	Black	Ruffino/Corinth. Vinyl		DF	Med. Ginger	RW	White w/Black
AY	Lt. Gray Gold	HA	Black	DR	Med. Green	RL	White w/Blue
Check B/Cloth and Corinth. Vinyl		HB	Med. Blue	ER	White	R9	White w/Tobacco
BA	Black	HT	Med. Beige	Random Stripe B/Cloth and Corinth. Vinyl		R5	White w/Green
BB	Med. Blue	Manston B/Cloth and Corinth. Vinyl		EA	Black	UA	Black
BF	Med. Ginger	JA	Black & White w/Black	EB	Med. Blue	UB	Med. Blue
BT	Med. Beige	JB	Blue & Black w/Med. Blue	EF	Med. Ginger	UF	Ginger
BY	Lt. Gray Gold	JF	Ginger & Black w/Med. Ginger	ER	Med. Green	UR	Med. Green
Province B/Cloth and Corinth. Vinyl		JT	Beige & Black w/Med. Beige	TORINO-RANCHERO		UW	White w/Black
CA	Black	JW	White & Black w/White	Melrose/Corinth. Vinyl		UL	White w/Blue
CB	Med. Blue	Ruffino/Corinth. Vinyl		AA	Black	U9	White w/Tobacco
CE	Vermilion	KA	Black	AB	Med. Blue	U5	White w/Green
CY	Lt. Gray Gold	KB	Med. Blue	AR	Med. Green	MONTEGO	
Sebring Knit/Corinth. Vinyl		KF	Med. Ginger	Sphere B/Cloth and Corinth. Vinyl		Selkirk B/Clock and Corinth. Vinyl	
EA	Black	KT	Med. Beige	BA	Black	AA	Black
EB	Med. Blue	KW	White w/Black	BB	Med. Blue	AB	Med. Blue
EE	Vermilion	KL	White w/Blue	BR	Med. Green	AR	Med. Green
EY	Lt. Gray Gold	KS	White w/Ginger	BY	Lt. Gray Gold	Tahiti/Corinth. Vinyl	
Sebring Knit/Corinth. Vinyl		K6	White w/Beige	BZ	Tobacco	BA	Black
FA	Black	Ruffino/Corinth. Vinyl		Ruffino/Corinth. Vinyl		BB	Med. Blue
FB	Med. Blue	LA	Black	CA	Black	BR	Med. Green
FE	Vermilion	LW	White w/Black	CB	Med. Blue	Sphere B/Cloth and Corinth. Vinyl	
FY	Lt. Gray Gold	LL	White w/Blue	CF	Ginger	CA	Black
Province B/Cloth and Corinth. Vinyl		LS	White w/Ginger	CR	Med. Green	CB	Med. Blue
GE	Vermilion	L6	White w/Beige	CW	White w/Black	CR	Med. Green
GY	Lt. Gray Gold	Manston B/Cloth and Corinth. Vinyl		CL	White w/Blue	CY	Lt. Gray Gold
Ruffino/Corinth. Vinyl		MW	White & Black w/White	C9	White w/Tobacco	CZ	Tobacco
HA	Black	MUSTANG		C5	White w/Green	Ruffino/Corinth. Vinyl	
HB	Med. Blue	Ruffino/Corinth. Vinyl		Balmoral B/Cloth and Corinth. Vinyl		DA	Black
HF	Med. Ginger	AA	Black	DA	Black	DB	Med. Blue
HT	Med. Beige	AB	Med. Blue	DF	Ginger	DR	Ginger
Manston B/Cloth and Corinth. Vinyl		AE	Vermilion	EA	Black	OR	Med. Green
JA	Black & White w/Black	AF	Med. Ginger	EF	Ginger	DW	White w/Black
JB	Blue & Black w/Med. Blue	AR	Med. Green	VA	Black	DL	White w/Blue
JF	Ginger & Black w/Med. Ginger	AW	White	VF	Ginger	D9	White w/Tobacco
JT	Beige & Black w/Med. Beige	Sebring Knit/Corinth. Vinyl		Ruffino/Corinth. Vinyl		O5	White w/Green
JW	White & Black w/White	CA	Black	FA	Black	Sebring Knit/Corinth. Vinyl	
Ruffino/Corinth. Vinyl		CB	Med. Blue	FB	Med. Blue	EA	Black
KA	Black	CE	Vermilion	FF	Ginger	EB	Med. Blue
KB	Med. Blue	CF	Med. Ginger	FR	Med. Green	EF	Ginger
KF	Med. Ginger	CW	White	FW	White w/Black	ER	Med. Green
KT	Med. Beige	Lambeth B/Cloth and Corinth. Vinyl		FL	White w/Blue	EW	White w/Black
KW	White w/Black	FA	Black	F9	White w/Tobacco	EL	White w/Blue
KL	White w/Blue	FB	Med. Blue	F5	White w/Green	E9	White w/Tobacco
KS	White w/Ginger	FE	Vermilion	GA	Black	E5	White w/Green
K6	White w/Beige	FF	Med. Ginger	GB	Med. Blue	FA	Black
Ruffino/Corinth. Vinyl		FR	Med. Green	GF	Ginger	FB	Med. Blue
LA	Black	MUSTANG		GR	Med. Green	FF	Ginger
LW	White w/Black	Ruffino/Corinth. Vinyl		Sebring Knit/Corinth. Vinyl		FR	Med. Green
LL	White w/Blue	AA	Black	HA	Black	FW	White w/Black

INTERIOR TRIM CODES

Code	Trim Scheme	Code	Trim Scheme	Code	Trim Scheme	Code	Trim Scheme
GR	Med. Green		Watchplaid B/Cloth and Corinth. Vinyl	VA	Black	K5	White w/Green
GY	Lt. Gray Gold	RA	Black	VB	Med. Blue	K9	White w/Tobacco
GZ	Tobacco	VA	Black	VD	Dk. Red	LINCOLN CONTINENTAL	
	Valino Grain w/Corinth. Vinyl	MERCURY		VF	Med. Ginger	Nottingham B/Cloth and Corinth. Vinyl - Wide Pleat	
HA	Black	AA	Covert B/Cloth and Corinth. Vinyl	VR	Med. Green	AA	Black
HB	Med. Blue	AB	Black	VY	Lt. Gray Gold	AF	Ginger w/Tobacco
HF	Ginger	AF	Med. Blue	VZ	Dk. Tobacco	AY	Lt. Gray Gold
HR	Med. Green	AR	Med. Ginger	METEOR		Beford Knit/B/Cloth and Corinth. Vinyl - Narrow Pleat	
HW	White w/Black	AY	Med. Green	AA	Black	BA	Black
HL	White w/Blue	BA	Lt. Gray Gold	AB	Med. Blue	BB	Dk. Blue
H9	White w/Tobacco	BD	Ruffino/Corinth. Vinyl	AY	Lt. Gray Gold	BD	Dk. Red
H5	White w/Green	BE	Black	Lobel B/Cloth and Corinth. Vinyl		BR	Dk. Green
FORD		BF	Med. Blue	BA	Black	BZ	Tobacco
Lobel B/Cloth and Ruffino/Corinth. Vinyl		BD	Dk. Red	BB	Med. Blue	Lamont B/Cloth and Corinth. Vinyl - Narrow Pleat	
AA	Black	BE	Med. Ginger	BY	Lt. Gray Gold	CA	Black
AB	Med. Blue	BF	Med. Green	Akron/Corinth. Vinyl		CY	Lt. Gray Gold
AY	Lt. Gray Gold	BW	White w/Black	CA	Black	Natural Grain Leather/Mateo Vinyl	
	Sebring Knit/Valino/Corinth. Vinyl	BY	Lt. Gray Gold	CB	Med. Blue	DA	Black
		CA	Hopsack B/Cloth and Corinth. Vinyl	CR	Med. Green	DB	Dk. Blue
BA	Black	CB	Black	CY	Lt. Gray Gold	DD	Dk. Red
BB	Med. Blue	CD	Med. Blue	Ruffino/Corinth. Vinyl		DF	Ginger w/Tobacco
BF	Med. Ginger	CF	Dk. Red	DA	Black	DR	Dk. Green
BR	Med. Green	CF	Med. Ginger	DB	Med. Blue	DW	White w/Black
	Heidelberg B/Cloth and Corinth. Vinyl	CR	Med. Green	DD	Dk. Red	DY	Lt. Gray Gold
DA	Black	DA	Sierra/Corinth. Vinyl	DF	Med. Ginger	DZ	Tobacco
DB	Med. Blue	DB	Black	DR	Med. Green	DL	White w/Blue
DD	Dk. Red	DD	Med. Blue	DY	Lt. Gray Gold	D5	White w/Green
DF	Med. Ginger	DE	Dk. Red	FA	Black	D9	White w/Tobacco
DR	Med. Green	DE	Med. Ginger	FB	Med. Blue	EA	Black
DY	Lt. Gray Gold	DF	Med. Green	FD	Dk. Red	EB	Dk. Blue
	Chateau/Lamont B/Cloth and Corinth. Vinyl	DW	White w/Black	FF	Med. Ginger	ED	Dk. Red
EA	Black	DY	Lt. Gray Gold	FR	Med. Green	EE	Dk. Green
EB	Med. Blue	FA	Black	FR	Med. Green	EW	White w/Black
ED	Dk. Red	FB	Med. Blue	FW	White w/Black	EL	White w/Blue
ER	Med. Green	FD	Dk. Red	FY	Lt. Gray Gold	E5	White w/Green
EY	Lt. Gray Gold	FF	Med. Ginger	JA	Black	E9	White w/Tobacco
EZ	Dk. Tobacco	FR	Med. Green	JB	Med. Blue	FA	Black
ZA	Black	FW	White w/Black	JD	Dk. Red	FB	Dk. Blue
ZB	Med. Blue	FY	Lt. Gray Gold	JE	Med. Ginger	FD	Dk. Red
ZD	Dk. Red	Empress/Bangor B/Cloth and Corinth. Vinyl		JR	Med. Green	FF	Med. Ginger w/Tobacco
ZR	Med. Green	GA	Black	KA	Black	FR	Dk. Green
ZY	Lt. Gray Gold	GB	Med. Blue	KB	Med. Blue	FY	Lt. Gray Gold
ZZ	Dk. Tobacco	GD	Dk. Red	KD	Dk. Red	FW	White w/Black
	Ruffino/Corinth. Vinyl	GR	Med. Green	KE	Med. Ginger	FZ	Dk. Tobacco
FA	Black	GY	Lt. Gray Gold	KF	Med. Green	FL	White w/Blue
FB	Med. Blue	GZ	Dk. Tobacco	KR	Med. Green	F5	White w/Green
FD	Dk. Red	KA	Black	Covert B/Cloth and Corinth. Vinyl		F9	White w/Tobacco
FF	Med. Ginger	KB	Med. Blue	EA	Black	Lamont B/Cloth and Corinth. Vinyl	
FR	Med. Green	KD	Dk. Red	EB	Med. Blue	GA	Black
FW	White w/Black	KY	Med. Green	EF	Med. Ginger	GT	Lt. Beige
FY	Lt. Gray Gold	KR	Med. Green	ER	Med. Green	Natural Grain Leather/Mateo Vinyl	
MA	Black	KZ	Lt. Gray Gold	EY	Lt. Gray Gold	HA	Black
MB	Med. Blue	LA	Dk. Tobacco	Alpha/Corinth. Vinyl		HT	Beige
MR	Med. Green	LB	Black	HA	Black	CONTINENTAL MARK IV	
MY	Lt. Gray Gold	LD	Med. Blue	HB	Med. Blue	Lamont B/Cloth and Corinth. Vinyl	
WA	Black	LE	Med. Blue	HF	Med. Ginger	AA	Black
WB	Med. Blue	LF	Dk. Red	HR	Med. Green	AB	Dk. Blue
WD	Dk. Red	LG	Med. Green	Watchplaid B/Cloth and Corinth. Vinyl		AD	Dk. Red
WF	Med. Ginger	LH	Lt. Gray Gold	MA	Black	AH	Cranberry
WR	Med. Green	LJ	Dk. Tobacco	Sebring Knit/Corinth. Vinyl		AR	Dk. Green
WY	Lt. Gray Gold	MA	Black	PA	Black	AY	Lt. Gray Gold
WW	White w/Black	MB	Med. Blue	PB	Med. Blue	Natural Grain Leather/Corinth. Vinyl	
	Samar B/Cloth and Corinth. Vinyl	MD	Dk. Red	PF	Med. Ginger	BA	Black
HA	Black	MR	Med. Green	PR	Med. Green	BB	Dk. Blue
HB	Med. Blue	MY	Lt. Gray Gold	THUNDERBIRD		BD	Dk. Red
HR	Med. Green	MZ	Dk. Tobacco	Hopsack/Bangor B/Cloth and Corinth. Vinyl		BF	Med. Ginger w/Tobacco
HY	Lt. Gray Gold	ZA	Black	GA	Black	BR	Dk. Green
	Alpha/Corinth. Vinyl	ZB	Med. Blue	GB	Dk. Blue	BY	Lt. Gray Gold
JA	Black	ZD	Dk. Red	GD	Dk. Red	BZ	Dk. Tobacco
JB	Med. Blue	ZR	Med. Green	GF	Ginger w/Tobacco	BW	White w/Black
JF	Med. Ginger	ZY	Lt. Gray Gold	GR	Dk. Green	BL	White w/Blue
JR	Med. Green	ZZ	Dk. Tobacco	Lamont B/Cloth and Corinth. Vinyl		B5	White w/Green
	Covert/Cloth and Corinth. Vinyl	JA	Black	HA	Black	B9	White w/Tobacco
KA	Black	JB	Med. Blue	HB	Dk. Blue		
KB	Med. Blue	JD	Dk. Red	HD	Dk. Red		
KF	Med. Ginger	JE	Med. Blue	HR	Dk. Green		
KR	Med. Green	JF	Ginger	HZ	Tobacco		
KY	Lt. Gray Gold	JR	Med. Green	Natural Grain Leather/Mateo Vinyl			
	Morocco/Corinth. Vinyl	JY	Lt. Gray Gold	KA	Black		
LU	Beige	JZ	Dk. Tobacco	KB	Dk. Blue		
	Akron/Ruffino/Corinth. Vinyl	NA	Black	KD	Dk. Red		
NA	Black	NB	Med. Blue	KE	Ginger w/Tobacco		
NB	Med. Blue	ND	Dk. Red	KR	Dk. Green		
NR	Med. Green	NF	Med. Ginger	KZ	Tobacco		
NR	Med. Green	NR	Med. Green	KW	White w/Black		
NY	Lt. Gray Gold	NY	Lt. Gray Gold	KL	White w/Blue		
NY	Lt. Gray Gold	NZ	Dk. Tobacco				

<h1 style="margin: 0;">Wheels and Tires</h1>	<p>GROUP 11</p>
--	-----------------------------------

PART 11-01	PAGE	PART 11-10	PAGE
General Wheel and Tire Service	11-01-01	Wheel Hubs and Bearings—Front	11-10-01
PART 11-02		PART 11-11	
Wheels and Tires—Drop Center Rim	11-02-01	Wheel Hubs and Bearings—Rear	11-11-01

PART 11-01 General Wheel and Tire Service

Applies to All Models			
COMPONENT INDEX	Page	COMPONENT INDEX	Page
FRONT WHEEL BEARING MAINTENANCE	01-01	TIRE SIZES	01-01
TIRE INSPECTION	01-02	WHEEL BALANCING	01-01
		WHEEL INSPECTION	01-02

3 ADJUSTMENTS

WHEEL BALANCING

See the instructions provided with the Rotunda Wheel Balancer.

Make certain that the brakes are not dragging before attempting to spin the wheels. On vehicles equipped with disc brakes, push the brake shoes into the caliper to free the rotor.

FRONT WHEEL BEARING MAINTENANCE

Wheel bearings are adjustable to correct for bearing and spindle shoulder wear. Satisfactory operation and long life of bearings depend on proper adjustment and correct lubrication. **If bearings are adjusted too tightly, they will**

overheat and wear rapidly. An adjustment that is excessively loose will cause pounding and contribute to uneven tire wear, steering difficulties and inefficient brakes. The bearing adjustment should be checked at regular inspection intervals.

TIRE SIZES

When replacing tires or wheels, it is **MANDATORY** to use only the standard or optional tire sizes and types recommended on the tire chart attached to the vehicle. Wheel rim widths and offsets must be those recommended by the car manufacturer for that tire size (see Fig. 1).

Tires and wheels other than those recommended above can adversely affect the safety and durability of your vehicle; and, therefore, **MUST NOT BE USED.**

All tires and wheels on the vehicle should be of the same size, type, and load carrying capacity. Never mix radial, belted, and/or conventional-type tires.

Snow tires should be of size and type equivalent to the other tires on the vehicle as recommended above.

Tires larger or smaller than originally installed may affect the accuracy of the speedometer, and require a change of speedometer drive gears.

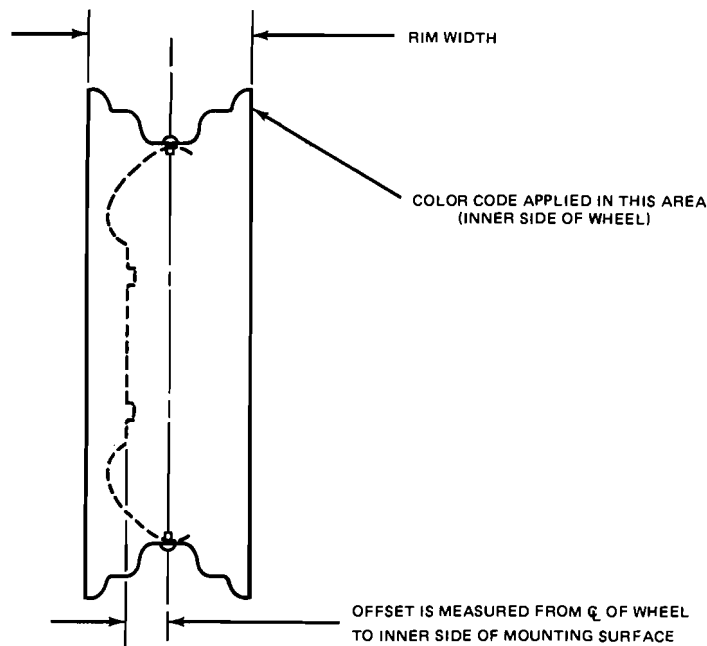

VEHICLE	TIRE SIZE RELEASED FOR USAGE	WHEEL SIZE	OFFSET	COLOR CODE
PINTO	6.00-13, A78-13	13 x 4	1.0	PINK
	A70-13, 175R13, 175-13	13 x 5	1.0	GREEN
MAVERICK/COMET	6.45-14, C78-14	14 x 4.5	0.0	YELLOW/ORANGE OR WHITE/ORANGE
	D70-14, DR78-14	14 x 6	0.0	BROWN/GREEN OR BROWN/VIOLET
MUSTANG/ COUGAR	F60-15 (MUSTANG ONLY)	15 x 7	0.0	GREEN OR ORANGE
	E78-14, E70-14, F70-14	14 x 6	0.0	BROWN/VIOLET
	E78-14, F70-14 (COUGAR ONLY)	14 x 7	0.0	WHITE/YELLOW
TORINO/ MONTEGO/ RANCHERO	E78-14, F78-14, G78-14	14 x 5	0.55	RED/GREEN
	H78-14, E70-14, F70-14, G70-14	14 x 6	0.25	
	8.25-15 (TORINO/MONTEGO POLICE)	15 x 6	0.45	PINK
	E78-15, F78-15, G78-15, R70-15, F70-15, G70-15 (TORINO/RANCHERO ONLY)	14 x 7	0.25	RED
FORD/MERCURY/ METEOR	F78-15, G78-15	15 x 5	0.45	WHITE/PINK
	H78-15	15 x 5.5	0.62	YELLOW
	HR78-15 (8.25-15 FORD POLICE)	15 x 6	0.45	PINK
	H78-15, HR78-15 (8.55-15 POLICE)	15 x 6.5	0.45	BROWN
THUNDERBIRD CONTINENTAL/ MARK IV/LINCOLN CONTINENTAL	215-15, 225-15	15 x 6	0.45	PINK

F1820-A

FIG. 1 Car Tire Wheel Combinations

5 CLEANING AND INSPECTION

WHEEL INSPECTION

Wheel hub nuts should be inspected and tightened to specification at predelivery. Loose wheel hub nuts may cause shimmy and vibration. Elongated stud holes in the wheels may also result from loose hub nuts. Hub nuts should be torqued to 70-115 ft-lbs.

Keep the wheels and hubs clean. Stones wedged between the wheel and drum and lumps of mud or grease can unbalance a wheel and tire.

Check for damage that would af-

fect the runout of the wheels. Wobble or shimmy caused by a damaged wheel will eventually damage the wheel bearings. Inspect the wheel rims for dents that could permit air to leak from the tires.

Front hubs and bearings should be cleaned, inspected and lubricated whenever the hubs are removed or at the mileage/time periods indicated in the maintenance schedule.

New hub grease seals should be installed when the hub is removed. An imperfect seal may permit bearing lubricant to reach the brake linings resulting

in faulty brake operation and necessitating premature cleaning or replacement of linings.

TIRE INSPECTION

Incorrect wheel alignment can cause tire wear. Abnormal or excessive tire wear can also be caused by wheel/tire unbalance or incorrect tire pressure. Typical tire wear patterns are shown in Fig. 2.

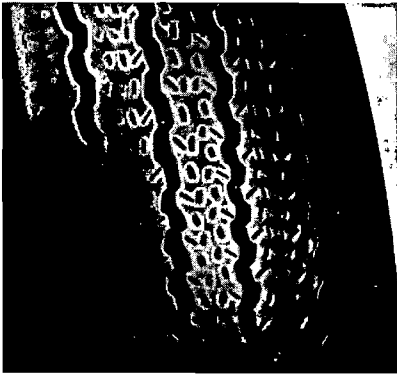

UNDERINFLATION

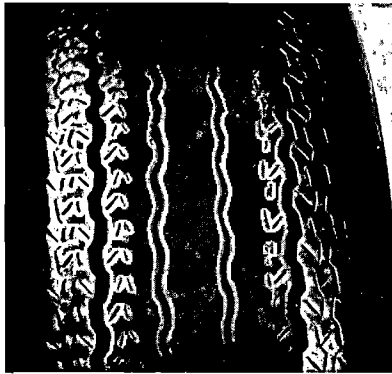

OVERINFLATION

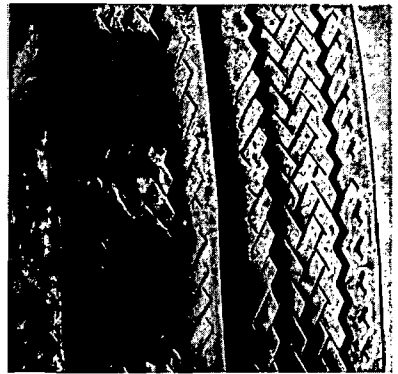

CUPPING—UNDERINFLATION AND/OR MECHANICAL IRREGULARITIES

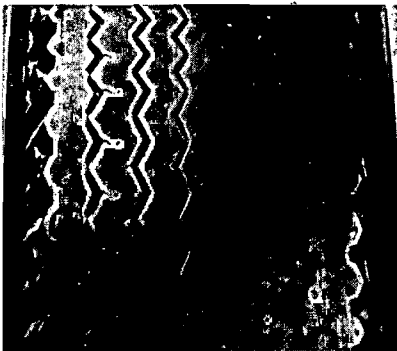

INCORRECT TOE-IN OR EXTREME CAMBER

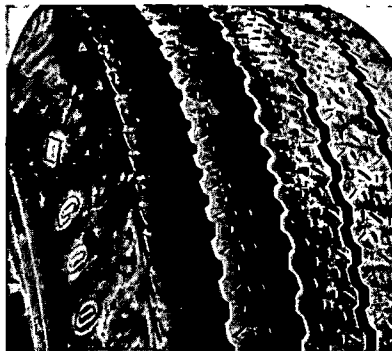

FEATHERING DUE TO MISALIGNMENT OR SEVERE CORNERING

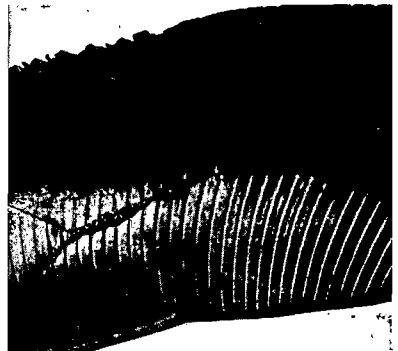

STONE BRUISE

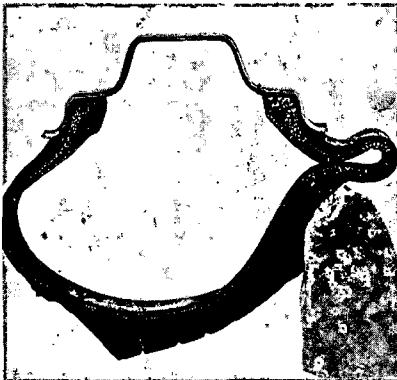

STONE BRUISE

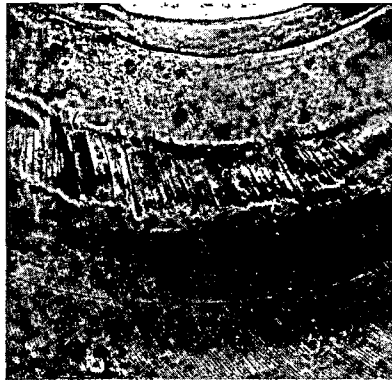

UNDERINFLATION

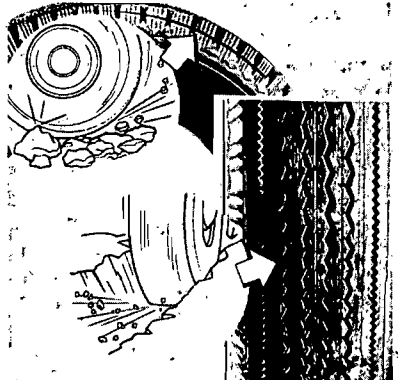

ROCK CUT

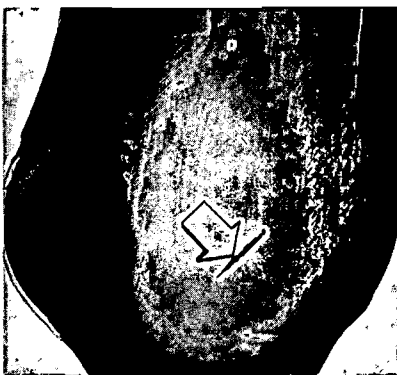

BRUISE

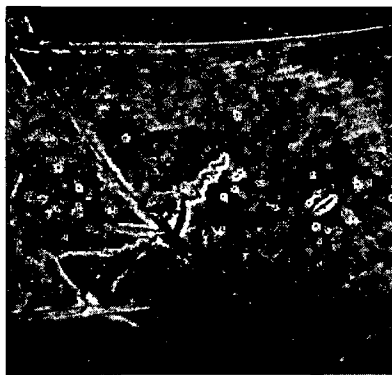

HEAT BRUISE



DOUBLE BRUISE—SHARP OBJECT AND RESULTING FATIGUE

F1467-D

FIG. 2 Tire Wear Conditions

PART 11-02 Wheels and Tires— Drop Center Rim

COMPONENT INDEX	Page	COMPONENT INDEX	Page
FRONT WHEEL ASSEMBLY		SPACE SAVER SPARE TIRE	
Description	02-02	Description	02-01
HOISTING INSTRUCTIONS	02-02	WHEELS AND TIRES	
REAR WHEEL ASSEMBLY		Removal and Installation	02-02
Description	02-02		

1 DESCRIPTION

SPACE SAVER SPARE TIRE

A space saver spare tire is available as a regular production option on Mustang vehicles.

The Space Saver Spare is designed primarily to provide more room in the luggage compartment. The tire is installed on the wheel in a deflated condition and protrudes barely beyond the periphery of the wheel; thereby, leaving extra storage space. Although more storage space is available, the vehicle full rated load specification must not be exceeded. This tire is not designed for extended mileage; therefore, it should not be used as a permanent substitute for conventional tires. The Space Saver Spare will enable the driver to drive at normal speed and load to the nearest service facility for repairs to a flat tire.

To inflate, carefully follow the instructions shown on the tire inflator can which is stowed under the tire and wheel assembly in the trunk. Use Inflator D1ZA-19F514-AA or Equivalent. Tire warranty for the Space Saver Spare is the same as original equipment tires. This warranty is void if inflators with sealants are used.

While inflating, keep hands off of metal parts of the inflator since the bottle becomes extremely cold during discharge. Read the instructions on the bottle label. Always dispose of the empty bottle. Do not puncture or incinerate.

The inflator, when completely used, will inflate the tire within specifications.

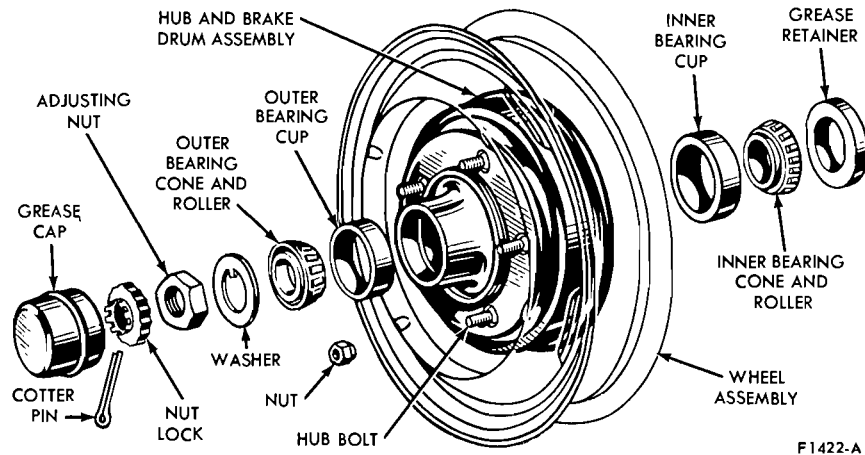

FIG. 1 Front Hub, Bearing and Grease Retainer Drum Brakes

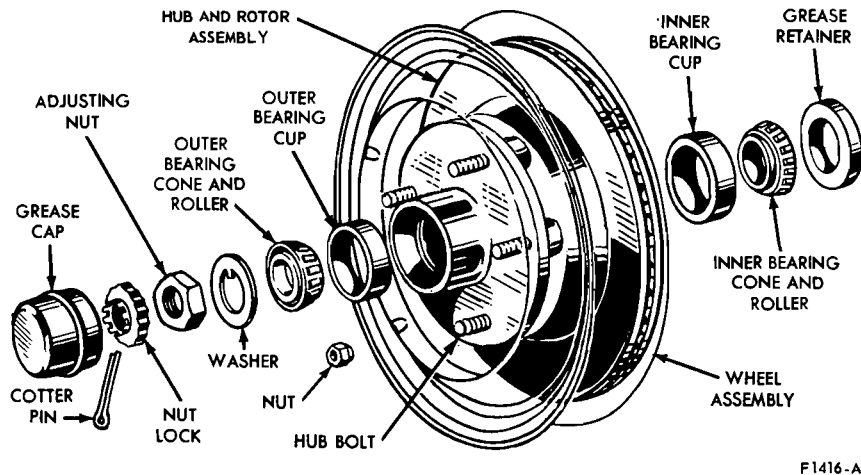

FIG. 2 Front Hub and Rotor Bearing and Grease Retainer Disc Brakes—Typical

The Space Saver Spare can, in case of a puncture, be repaired the same as an original equipment tire.

FRONT WHEEL ASSEMBLY

Each front wheel and tire is bolted to its respective front hub and brake drum or rotor assembly. Two opposed tapered roller bearings are installed in each hub. A grease retainer is installed

at the inner end of the hub to prevent lubricant from leaking into the drum or on the rotor. The entire assembly is retained to its spindle by the adjusting nut, nut lock and cotter pin (Figs. 1 and 2).

REAR WHEEL ASSEMBLY

The rear wheel hub and brake drum assembly is attached to studs on

the rear axle shaft flange by three speed nuts. The wheel and tire mounts on the same rear axle shaft flange studs and is held against the hub and drum by the wheel nuts. The rear wheel bearing is pressed onto the axle shaft just inside the shaft flange, and the entire assembly is retained to the rear axle housing by the bearing retainer plate which is bolted to the housing flange.

4 REMOVAL AND INSTALLATION

HOISTING INSTRUCTIONS

Damage to steering linkage components and front suspension struts may occur if care is not exercised when positioning the hoist adapters of 2 post hoists prior to lifting the vehicle.

If a 2 post hoist is used to lift the vehicle, place the adapters under the lower arms or (except for Pinto) the No. 1 crossmember. Do not allow the adapters to contact the steering linkage. If the adapters are placed under the crossmember, a piece of wood (2x4x16 inches) should be placed on the hoist channel between the adapters. This will prevent the adapters from damaging the front suspension struts.

WHEELS AND TIRES

Wheel and Tire Removal

1. Pry off the wheel hub cap or wheel cover. Loosen but do not remove the wheel hub nuts.
2. Raise the vehicle until the wheel and tire clear the floor.
3. Remove the wheel hub nuts from the bolts, and pull the wheel and tire from hub and drum.

Wheel and Tire Installation

1. Clean all dirt from the hub and drum.
2. Position the wheel and tire on the hub and drum. Install the wheel hub nuts and tighten them alternately to draw the wheel evenly against the hub and drum.
3. Lower the vehicle to the floor, and torque the hub nuts to specification.

Removing Conventional Tire From Wheel

The tire can be demounted on a mounting machine. Be sure that the outer side of the wheel is positioned downward. If tire irons are used, follow the procedure given here.

1. Remove the valve cap and core, and deflate the tire completely.
2. With a bead loosening tool, break loose the tire side walls from the wheel (Fig. 3).

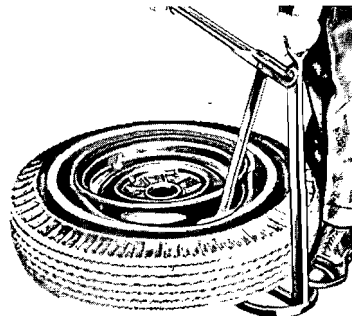

F1424 A

FIG. 3 Loosening Tire Bead

3. Position the outer side of the wheel downward, and insert two tire irons about eight inches apart between the tire inner bead and the back side of the wheel rim. Use only tire irons with rounded edges or irons designed for removing tubeless tires.
4. Leave one tire iron in position, and pry the rest of the bead over the rim with the other iron. Take small bites with the iron around the tire in order to avoid damaging the sealing surface of the tire bead.
5. Stand the wheel and tire upright with the tire outer bead in the drop center well at the bottom of the wheel. Insert the tire iron between the bead and the edge of the wheel rim and pry the wheel out of the tire.

Mounting Conventional Tire To Wheel

1. If a used tire is being installed remove all dirt from the tire.
- If a tire is being mounted to the original wheel, clean the rim with emery cloth or fine steel wool. Check the rim for dents.

If a new wheel is being installed, coat a new valve with RUGLYDE or similar rubber lubricant and position the valve to the new wheel. Use a rubber hammer or a valve replacing tool to seat the valve firmly against the inside of the rim.

2. Apply RUGLYDE or a similar rubber lubricant to the sealing surface on both tire beads. With the outer side of the wheel down, pry the beads over the wheel rim with two tire irons. Do not use a hammer or mallet to force the beads over the rim.

3. Align the balance mark on the tire with the valve on the wheel.

4. Hold the beads against the rim flanges by positioning a tire mounting band over the tire (Fig. 4). If a mounting band is not available, tie a tourniquet of heavy cord around the circumference and in the center of the tire. Tighten the cord with a tire iron. Center the tire on the wheel with a rubber mallet.

5. Give the tire a few quick bursts of air to seat the beads properly, then inflate the tire to 40 psi pressure. Check to see that the bead positioning rings (outer rings near the side walls) are evenly visible just above the rim flanges all the way around the tire. If the rings are not even, deflate the tire completely and inflate it again.

6. When the rings are properly positioned, deflate the tire to the recommended pressure.

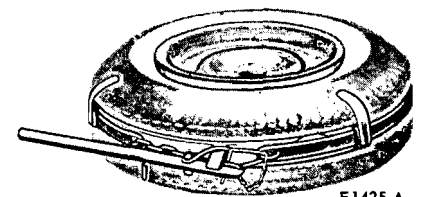

F1425-A

FIG. 4 Tubeless Tire Mounting Band

PART 11-10 Wheel Hubs and Bearings—Front

Applies to All Models			
COMPONENT INDEX	Page	COMPONENT INDEX	Page
FRONT HUB AND DRUM ASSEMBLY Removal and Installation	10-04	FRONT WHEEL GREASE SEAL Removal and Installation	10-02
FRONT HUB AND ROTOR ASSEMBLY Removal and Installation	10-04	HOISTING INSTRUCTIONS	10-01
FRONT WHEEL ASSEMBLY Description	10-01	SPECIAL TOOLS	10-04
		FRONT WHEEL BEARINGS Adjustment	10-01

1 DESCRIPTION

FRONT WHEEL ASSEMBLY

Each front wheel and tire is bolt-

ed to its respective front hub and brake drum or rotor assembly. Two opposed tapered roller bearings are installed in each hub. A grease retainer is installed at the inner end of the hub to prevent

lubricant from leaking into the drum or on the rotor. The entire assembly is retained to its spindle by the adjusting nut, nut lock and cotter pin (Figs. 1 and 2, Part 11-02, Section 1).

3 ADJUSTMENTS

HOISTING INSTRUCTIONS

Damage to steering linkage components and front suspension struts may occur if care is not exercised when positioning the hoist adapters of 2 post hoists prior to lifting the vehicle.

If a 2 post hoist is used to lift the vehicle, place the adapters under the lower arms or (except Pinto) the No. 1 crossmember. Do not allow the adapters to contact steering linkage. If the adapters are placed under the crossmember, a piece of wood (2 x 4 x 16 inches) should be placed on the hoist channel between the adapters. This will prevent the adapters from damaging the front suspension struts.

FRONT WHEEL BEARING ADJUSTMENT

The front wheel bearings should be adjusted if the wheel is loose on the spindle or if the wheel does not rotate freely. The following procedures will bring the bearing adjustment to specification.

Drum Brakes

1. Raise the vehicle until the wheel and tire clear the floor.
2. Pry off the hub cap or wheel cover and remove the grease cap from the hub.

3. Wipe the excess grease from the end of the spindle, and remove the cotter pin and nut lock.

4. While rotating the wheel, hub, and drum assembly, torque the adjusting nut to 17-25 ft-lbs to seat the bearings (Fig. 1).

5. Back off the adjusting nut one half turn. Retighten the adjusting nut to 10-15 in.-lbs with a torque wrench or finger tight.

6. Position the nut lock on the adjusting nut so that the castellations on the lock are aligned with the cotter pin hole in the spindle, and install a new cotter pin. Bend the ends of the cotter pin around the castellated flange of the nut lock.

7. Check the front wheel rotation. If the wheel rotates properly, install the grease cap and the hub cap or wheel cover. If the wheel still rotates roughly or noisily, clean, inspect or replace the bearings and cups as required.

Disc Brakes

1. Raise the vehicle until the wheel and tire clear the floor.
2. Pry off the wheel cover and remove the grease cap from the hub.
3. Wipe the excess grease from the end of the spindle, and remove the adjusting nut cotter pin and nut lock.
4. Loosen the bearing adjusting nut three turns. Then, rock the wheel, hub, and rotor assembly in and out sev-

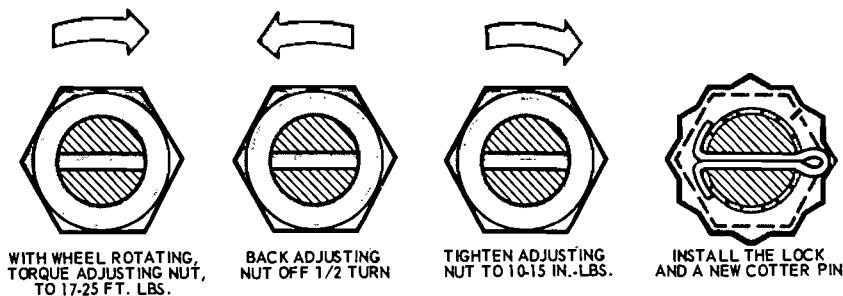

FIG. 1 Front Wheel Bearing Adjustment

eral times to push the shoe and linings away from the rotor.

5. While rotating the wheel, hub, and rotor assembly, torque the adjusting nut to 17-25 ft-lbs to seat the bearings (Fig. 1).

6. Back the adjusting nut off one half turn. Retighten the adjusting nut to 10-15 in-lbs with a torque wrench or finger tight.

7. Locate the nut lock on the adjusting nut so that the castellations on the lock are aligned with the cotter pin hole in the spindle.

8. Install a new cotter pin, and bend the ends of the cotter pin around the castellated flange of the nut lock.

9. Check the front wheel rotation. If the wheel rotates properly, install the grease cap and the hub cap or wheel

cover. If the wheel still rotates roughly or noisily, clean or replace the bearings and cups as required.

10. Before driving the vehicle, pump the brake pedal several times to obtain normal brake lining to rotor clearance and restore normal brake pedal travel.

4 REMOVAL AND INSTALLATION

HOISTING INSTRUCTIONS

Damage to steering linkage components and front suspension struts may occur if care is not exercised when positioning the hoist adapters of 2 post hoists prior to lifting the vehicle.

If a 2 post hoist is used to lift the vehicle, place the adapters under the lower arms or (except for Pinto), the No. 1 crossmember. Do not allow the adapters to contact the steering linkage. If the adapters are placed under the crossmember, a piece of wood (2x4x16 inches) should be placed on the hoist channel between the adapters. This will prevent the adapters from damaging the front suspension struts.

FRONT WHEEL GREASE SEAL AND BEARING REMOVAL, INSTALLATION AND/OR REPACKING

If bearing adjustment will not eliminate looseness or rough and noisy operation, the hub and bearings should be cleaned, inspected, and repacked with specified wheel grease. If the bearing cups or the cone and roller assemblies are worn or damaged, they should be replaced.

Drum Brakes

1. Raise the vehicle until the wheel and tire clear the floor.

2. Remove the wheel cover or hub cap. Remove the grease cap from the hub. Remove the cotter pin, nut lock, adjusting nut, and flat washer from the spindle. Remove the outer bearing cone and roller assembly (Fig. 1, and 2 Part 11-02, Section 1).

3. Pull the wheel, hub, and drum assembly off the wheel spindle.

4. Remove the grease retainer with Tool 1175AB and discard. Remove the inner bearing cone and roller assembly from the hub.

5. Clean the lubricant off the inner and outer bearing cups with solvent and inspect the cups for scratches, pits,

excessive wear, and other damage. If the cups are worn or damaged, remove them with Tool T69L-1102-A (Fig. 2).

6. Thoroughly clean the inner and outer bearing cone and roller assemblies with solvent and dry them thoroughly. Do not spin the bearings with compressed air.

Inspect the cone and roller assemblies for wear or damage, and replace them if necessary. The cone and roller assemblies and the bearing cups should be replaced as a unit if damage to either is encountered.

7. Thoroughly clean the spindle and the inside of the hub with solvent to remove all old lubricant.

Cover the spindle with a clean cloth, and brush all loose dust and dirt from the brake assembly. To prevent

getting dirt on the spindle, carefully remove the cloth from the spindle.

8. If the inner and/or outer bearing cup(s) were removed, install the replacement cup(s) in the hub with the tool shown in Fig. 3. Be sure to seat the cups properly in the hub.

9. Pack the inside of the hub with specified wheel bearing grease. Add lubricant to the hub only until the grease is flush with the inside diameter of both bearing cups (Fig. 4).

10. All old grease should be completely cleaned from the bearings and surrounding surfaces before repacking them with new grease (CIAZ-19590-B). The new lithium base grease is not compatible with sodium base grease which may have been present on the bearing surfaces. Pack the bearing cone and roller assemblies with wheel bearing grease. A bearing packer is desirable for this operation. If a packer is not available, work as much lubricant as possible between the rollers and cages. Lubricate the cone surfaces with grease.

11. Place the inner bearing cone and roller assembly in the inner cup. Apply a light film of grease to the lip(s) of the grease retainer and install the new grease retainer with the reverse end of the tool shown in Fig. 3. Be sure that the retainer is properly seated.

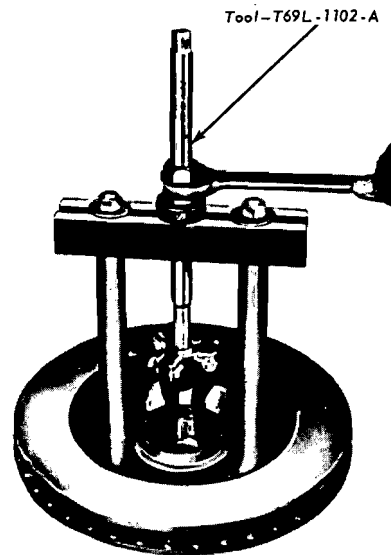

F1476-A

FIG. 2 Removing Front Wheel Bearing Cups—Disc (Drum-Type Similar)

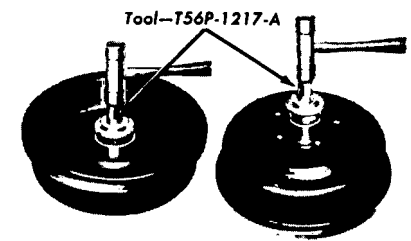
INNER CUP
INSTALLATIONOUTER CUP
INSTALLATION

F1464-A

FIG. 3 Installing Front Wheel Bearing Cups—Drum